

### 1. Mark

1) Use template provided to mark door for drilling 104.2cm (41") from base of the door or 14cm (5-1/2") above door knob or lever center to center

2) Use the template to select backset 60mm (2-3/8") or 70mm (2-3/4")

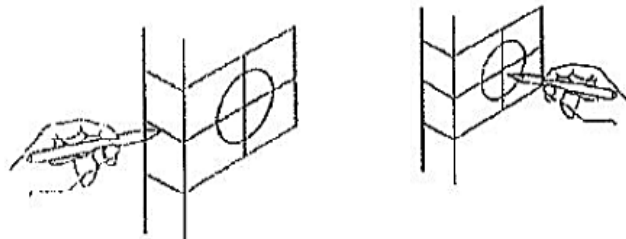

### 2. Drill Holes

1) Bores 54mm (2-1/8") hole through door face from both sides of door to avoid damaging door surface

2) Drill 25mm (1") hole through door edge

3) Drill the optional thru-bolt hole to make a more secure installation

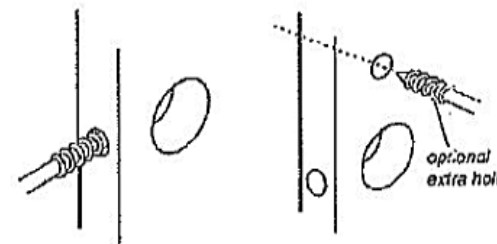

### 3. Install Deadbolt

1) Insert deadbolt latch into hole, secure the face plate all around and the screw hole

2) Chisel recess for face plate

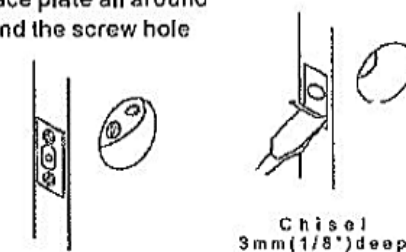

Chisel 3mm (1/8") deep

### 3) Deadbolt

**CAUTION: Deadbolt is preset at factory for 60mm (2-3/8")**

#### i) Converting 60mm (2-3/8") to 70mm (2-3/4") BACKSET

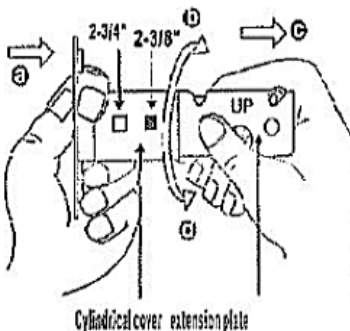

- Always press deadbolt with thumb, make sure to face with UP indication
- Rotate the cylindrical cover clockwise
- Then pull the extension plate all the way out
- Then rotate the cylindrical cover counter-clockwise to 70mm (2-3/4") position

**● IMPORTANT: Always press deadbolt with thumb.**

#### ii) Your latch is now set 70mm (2-3/4") backset

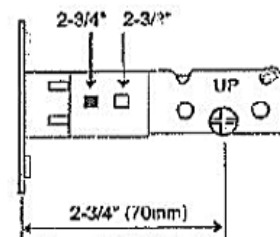

#### 4) Secure latch with screws

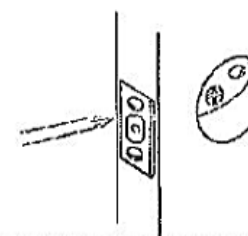

#### 5) Make sure the face plate of the latch is even with edge of door

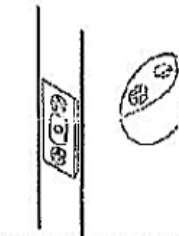

#### iii) Converting 70mm (2-3/4") to 60mm (2-3/8") BACKSET

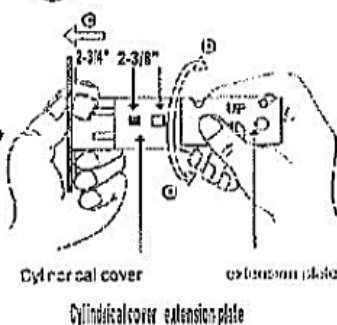

- Always press deadbolt with thumb, make sure to face with UP indication
- Rotate the cylindrical cover clockwise
- Then push the extension plate all the way in
- Then rotate the cylindrical cover counter-clockwise to 60mm (2-3/8") position

#### iv) Your latch is now set 60mm (2-3/8") backset

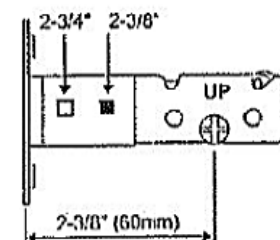

### Drill Holes And Install Strike Plate

#### 1) Mark jamb

- Close door until deadbolt latch touches door jamb. Mark door jamb as shown with a pencil
- Center the strike plate on the door jamb

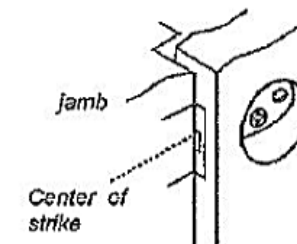

#### 2) Mark outline of strike plate

- Measure one half of door thickness from door stop and vertically mark drill point center for strike
- Place strike plate in position and mark outline of strike plate

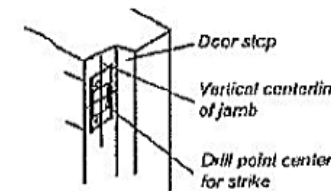

#### 3) Drill hole

Drill 25mm (1") hole in door jamb

**CAUTION: Hole in door jamb must be drilled 25mm (1") deep**

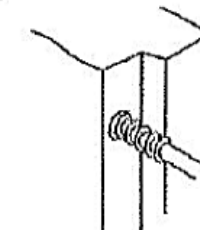

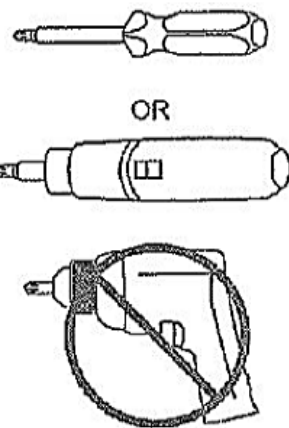

### 1. Mark

1) Use template provided to mark door for drilling 104.2cm (41") from base of the door or 14cm (5-1/2") above door knob or lever center to center

2) Use the template to select backset 60mm (2-3/8") or 70mm (2-3/4")

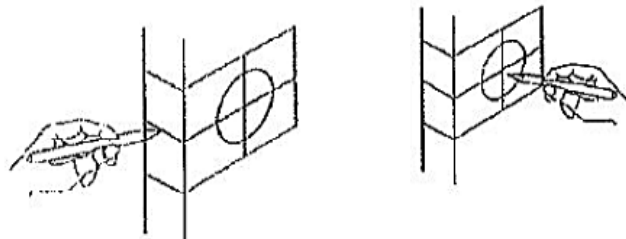

### 2. Drill Holes

1) Bores 54mm (2-1/8") hole through door face from both sides of door to avoid damaging door surface

2) Drill 25mm (1") hole through door edge

3) Drill the optional thru-bolt hole to make a more secure installation

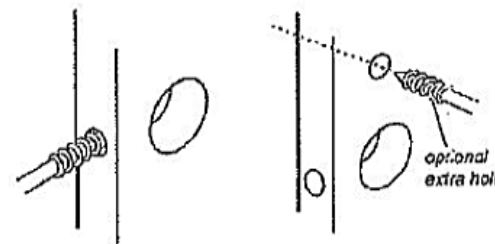

### 3. Install Deadbolt

1) Insert deadbolt latch into hole, secure the face plate all around and the screw hole

2) Chisel recess for face plate

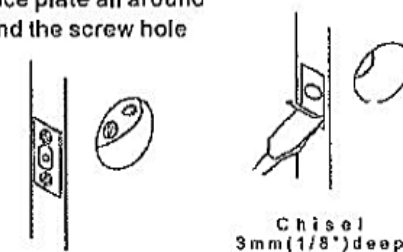

Chisel 3mm (1/8") deep

### 3) Deadbolt

**CAUTION: Deadbolt is preset at factory for 60mm (2-3/8")**

#### i) Converting 60mm (2-3/8") to 70mm (2-3/4") BACKSET

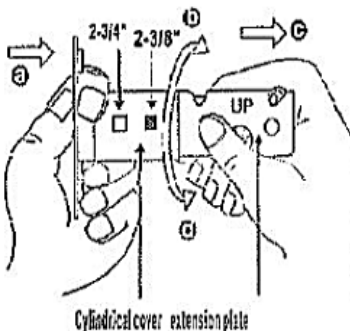

- Always press deadbolt with thumb, make sure to face with UP indication
- Rotate the cylindrical cover clockwise
- Then pull the extension plate all the way out
- Then rotate the cylindrical cover counter-clockwise to 70mm (2-3/4") position

**● IMPORTANT: Always press deadbolt with thumb.**

#### ii) Your latch is now set 70mm (2-3/4") backset

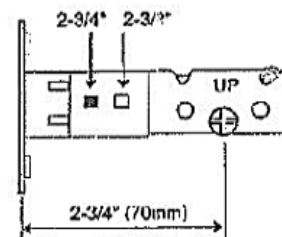

#### i) Converting 70mm (2-3/4") to 60mm (2-3/8") BACKSET

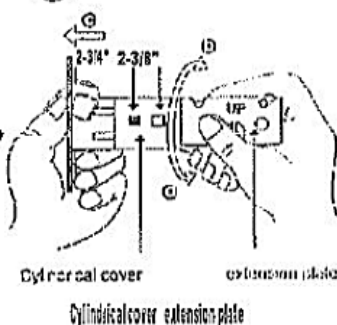

- Always press deadbolt with thumb, make sure to face with UP indication
- Rotate the cylindrical cover clockwise
- Then push the extension plate all the way
- Then rotate the cylindrical cover counter-clockwise to 60mm (2-3/8") position

#### ii) Your latch is now set 60mm (2-3/8") backset

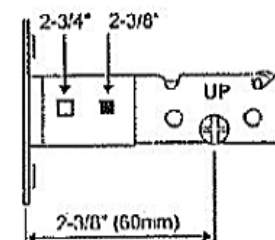

#### 4) Secure latch with screws

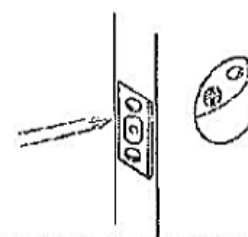

#### 5) Make sure the face plate of the latch is even with edge of door

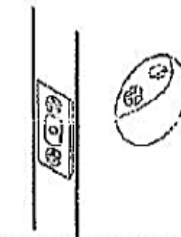

### Drill Holes And Install Strike Plate

#### 1) Mark jamb

- Close door until deadbolt latch touches door jamb. Mark door jamb as shown with a pencil
- Center the strike plate on the door jamb

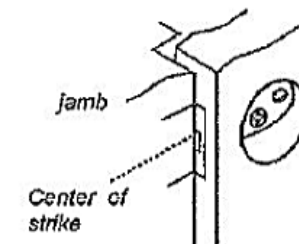

#### 2) Mark outline of strike plate

- Measure one half of door thickness from door stop and vertically mark drill point center for strike
- Place strike plate in position and mark outline of strike plate

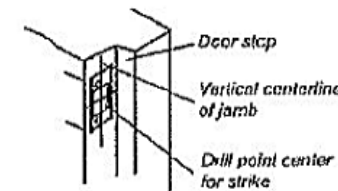

#### 3) Drill hole

Drill 25mm (1") hole in door jamb

**CAUTION: Hole in door jamb must be drilled 25mm (1") deep**

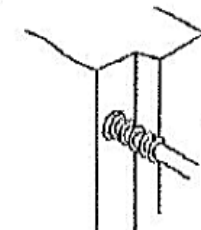

## 5. Install Strike Plate

- 1) Chisel outline for strike plate 3mm (1/8") deep or until plate is flush with door jamb
- 2) Install strike plate with screws

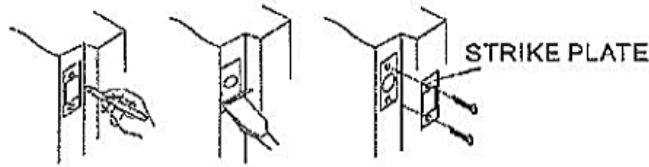

## B. INSTALLATION OF DEADBOLT ASSEMBLY

1. Open the door to ease installation and ensure deadbolt is retracted
2. Place the exterior deadbolt assembly on the exterior of the door over the rubber gasket aligning tailpiece horizontally through the deadbolt latch, while passing the wire under the deadbolt latch to the interior side the door

### IMPORTANT:

1. Key hole should be in down position, as diagram ①
2. Tailpiece of exterior cylinder should be inserted horizontally through deadbolt latch hole first
3. The wire should be pulled beneath the latch

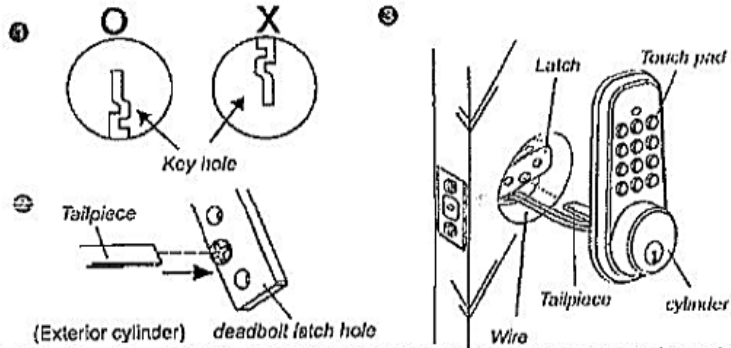

(Exterior cylinder) deadbolt latch hole

3. On interior side of door, place mounting plate and route the wire through square (1) on mounting plate
4. Secure and fasten mounting plate with 2 screws which with threaded of exterior key cylinder
5. Secure mounting plate to optional thru-bolt post (if used)

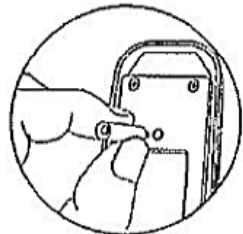

### IMPORTANT:

1. Be careful about the wire. Do not block the screw holes at the time of mounting the screws.
2. Ensure the mounting plate is positioned vertically

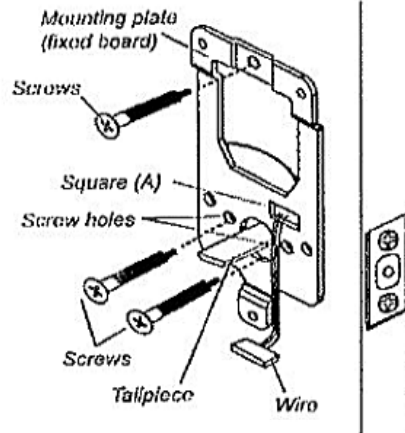

## C. ADJUSTING INTERIOR MODULE

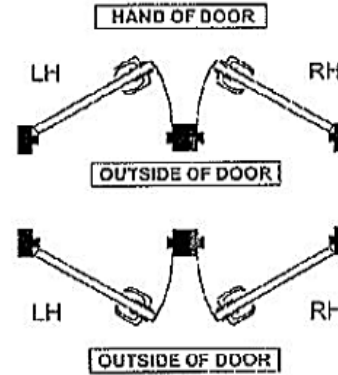

1. Check whether your door is right or left handed by standing outside and checking which side of the door the hinges are on:

If the hinges are on the left side, the door is left handed.

If the hinges are on the right side, the door is right handed.

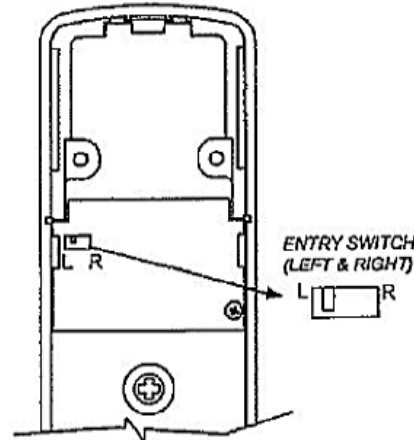

2. If you have a right handed door, move the entry switch to "R" by pen. If you have a left-handed door move the entry switch to "L" by pen.

## D. INSTALLATION OF INTERIOR MODULE

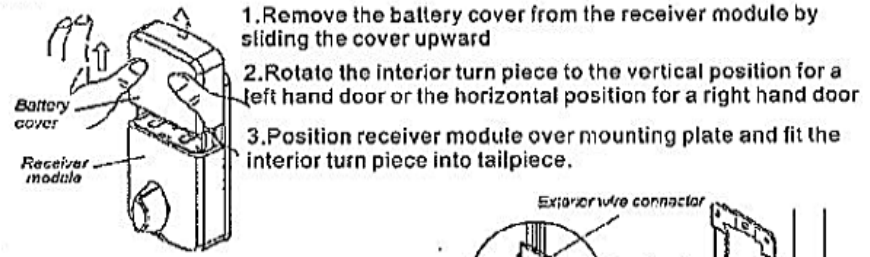

1. Remove the battery cover from the receiver module by sliding the cover upward
2. Rotate the interior turn piece to the vertical position for a left hand door or the horizontal position for a right hand door
3. Position receiver module over mounting plate and fit the interior turn piece into tailpiece.

4. Check operation of the deadbolt manually turning the turn piece or using the key. Bolt should extend and retract freely. If bolt cannot be moved freely, the direction turn piece is in the wrong place. Move receiver module and turn the turn piece to the opposite the opposite direction. Install again and check the operation of bolt

5. Connect exterior wire connector to interior wire connector.
6. Secure the receiver module to mounting plate with 3 screws.

### IMPORTANT:

1. Be careful about the wire. Do not block the screw holes at the time of mounting screws.
2. Lock should be straight on door before tightening screws.

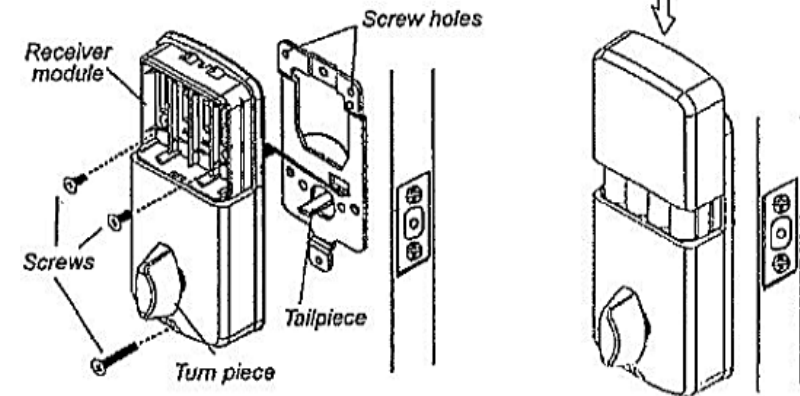

7. Instal(4)AA alkaline batteries and fit battery cover.